

**boreal**  
**rollers**

destiny

[destinyanddesign.com](http://destinyanddesign.com)

**lisos**  
**plain**

**night**  
**& day**  
**noche / día**

**night & day** **noche / día**

**destiny**

[destinyanddesign.com](http://destinyanddesign.com)



night & day noche / día

**night  
& day**

noche / día

**Your best ally**



# cris acid



Fabricación: corte cuchilla circular, corte ultrasonido.  
#Making up: rotating knife cutting, ultrasonic cutting



USO  
maintenance



## Ficha Técnica / Technical Data

	CRIS ACID TRANSLUCENT PART PARTE TRANSLÚCIDA	CRIS ACID OPAQUE PART PARTE OPACA
Composition / Composición	Polyester 100%	Polyester 100%
Transmittance / Transparencia	12,2 %	
Weight / Peso	174 g/m <sup>2</sup>	174 g/m <sup>2</sup>
Thickness / Espesor		0,48 mm
Tensile Strength (atN5cm) / Resistencia a la tracción	warp-urd. 64 - weft-frame 410	warp-urd. 2600 - weft-frame 410
Light Fastness / Resistencia a la luz	3 grade	3 grade
Fire Rating / Clasificación Infrago	NFPA 701	NFPA 701
Width / Ancho	280 cm.	280 cm.

destiny

Your best ally



# cris acid

C . 18100



66



55

# crisnatur



**FINE REZANDIT**

Fabricación: corte cuchilla circular, corte ultrasonido.  
#Making up: rotating knife cutting, ultrasonic cutting.



## Ficha Técnica / Technical Data

	CRISNATUR TRANSLUCENT PART PARTE TRANSLÚCIDA	CRISNATUR OPAQUE PART PARTE OPACA
Composition / Composición	Polyester 100%	Polyester 100%
Transmittance / Transparencia	12,2 %	
Weight / Peso	174 g/m <sup>2</sup>	174 g/m <sup>2</sup>
Thickness / Espesor		0,48 mm
Tear Strength (N/50mm) / Resistencia a la tracción	warp-ord. 04 - weft-frame 410	warp-ord. 2900 - weft-frame 410
Light Fastness / Resistencia a la luz	3 grade	3 grade
Fire Rating / Clasificación antigrupo	NFPA 701	NFPA 701
Width / Ancho	280 cm.	280 cm.

destiny

Your best ally



# crisnatur

comp. 9500



1



2



3



4



# crystal



**FIRE RESISTANT**

Fabricación: corte cuchilla circular, corte ultrasonido.  
 \*\*Moulding up: rotating knife cutting, ultrasonic cutting



## Ficha Técnica / Technical Data

	CRISTAL THIN PART PARTE TENUE	CRISTAL THICK PART PARTE DENSA
Composition / Composición	Polyester 100%	Polyester 85 % - Metal Fibre 14,5 %
Transmittance / Transparencia	80,2 %	29 %
Weight / Peso	71,4 g/m <sup>2</sup>	71,4 g/m <sup>2</sup>
Thickness / Espesor	0,12 mm.	0,18 mm.
Tensile Strength (del/ten) / Resistencia a la tracción	warp-uni. 170 - weft-tram 160	warp-uni. 1800 - weft-tram 160
Light Fastness / Resistencia a la luz	(SN-CW58, 7f) > 3-4 grade	(Other colors / Otros colores) > 6-7 grade
Fire Rating / Clasificación intigo	NFPA 701	NFPA 701
Width / Ancho	260 cm.	290 cm.

**destiny**

Your best ally



# crystal

composición 4700



S 3D-101



S 3D-110



SN-CM78



SN-CM88



S 3D-103



S 3D-107

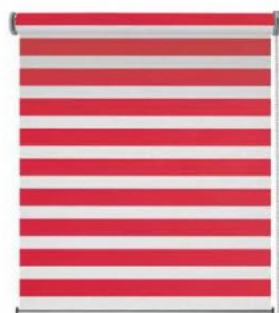

S 3D-178



S 3D-157



S 3D-175



# cristalmetal elio



Fabricación: corte cuchilla circular, corte ultrasónico.  
#Making up: rotating knife cutting, ultrasonic cutting



USO  
maintenance



## Ficha Técnica / Technical Data CRISTALMETAL ELIO

Composición / Composición	Polyester 100 %
Transparencia / Transparencia	42,6 %
Weight / Peso	95 g / m <sup>2</sup> ± 5%
Thicknesa / Espesor	0,30 mm. ±5%
Light Fastness / Resistencia a la luz	4 grade
Width / Ancho	275 cm.

destiny

Your best ally



# crystalmetal elio

C . 17600



CRISTALMETAL ELIO 1



CRISTALMETAL ELIO 2



eagle



Hersteller: VOGEL-TEKSTIL-VOGEL  
 Herstellung: in Italien bei VOGEL-TEKSTIL-VOGEL  
 Marken-Design: VOGEL-TEKSTIL-VOGEL

**FINE REVOLUTION**

Fabricación: corte cuchilla atornillada, corte ultrasónico.  
 Making up: rotating knife cutting, ultrasonic cutting.



Ficha Técnica / Technical Data

	EAGLE	
	TRANSLUCENT PART PARTE TRANSLUCIDA	OPAQUE PART PARTE OPACA
Composition / Composición	polyester 100%	polyester 100%
Transmittance / Transparencia	81,5 %	49,0 %
Weight / Peso	107,3 g/m <sup>2</sup>	107,3 g/m <sup>2</sup>
Thickness / Espesor	0,21 mm.	0,31 mm.
Tensile Strength (at Break) / Resistencia a la tracción	resp.-unif. 330,1 - web-frame 248	resp.-unif. 1300,8 - web-frame 280,8
Light Fastness / Resistencia a la luz	> 5 grado	> 5 grado
Fire Rating / Clasificación antilago	NFPA 701	NFPA 701
Width / Ancho	280 cm.	280 cm.

destiny

Your best ally



# eagle

composición 6200



NTWE - 001



NTWE - 002



NTWE - 003

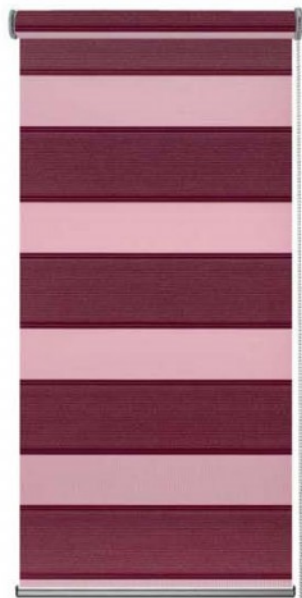

NTWE - 004

# elegance



Textil "Confederate" este produs în România și este în posesia drepturilor de autor CONFEDERATE



Fabricație: corp cuștilor circular, corp ultrasonificat.  
 2) Making up: rotating knife cutting, ultrasonic cutting



## Ficha Técnica / Technical Data

ELEGANCE

Composition / Composición	Polyester 100%
Transmittance / Transparencia	22,9 % - 83,7%
Weight / Peso	188 g/m <sup>2</sup>
Thickness / Espesor	0,66 mm. - 0,2 mm
Tensile Strength (Fabrica) / Resistencia la tracción	Min 3270,4 (Min 188,8 - max. 131,8)
Light Fastness / Resistencia a la luz	5 grade
Fire Rating / Clasificación antigraso	MPPA 701
Width / Ancho	290 cm.

destiny

Your best ally

elegance

composición 4900



SN-R13

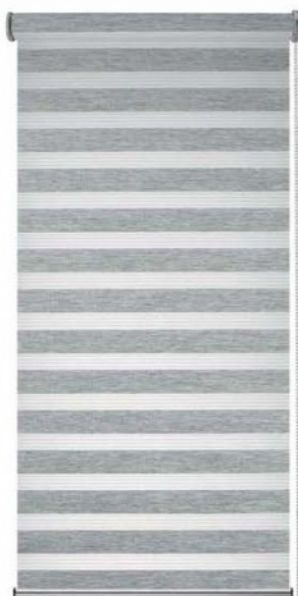

SN-R47



SN-R42



SN-R211



SN-R207



SN-R212



# elio



Fabricación: corte cuchilla circular, corte ultrasonido.  
 #Making up: rotating knife cutting, ultrasonic cutting



USO  
 maintenance



## Ficha Técnica / Technical Data

ELIO

Composition / Composición	Polyester 100 %
Transmittance / Transparencia	42,6 %
Weight / Peso	95 g / m <sup>2</sup> ±5%
Thickness / Espesor	0,30 mm. ±5%
Tensile Strength (daN/cm) / Resistencia a la tracción	warp 400 daN/5cm. / weft 370 daN/5cm.
Light Fastness / Resistencia a la luz	4 grade
Width / Ancho	275 cm.

destiny

Your best ally

**elio**

comp. 17400



ELIO 1



ELIO 2

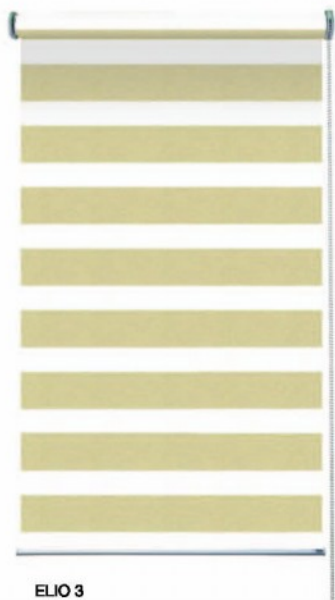

ELIO 3

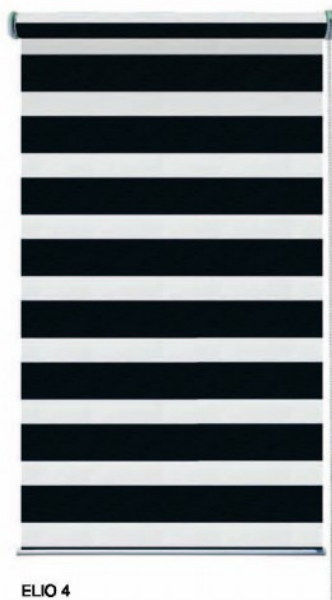

ELIO 4



encant



Textil: for beautiful atmosphere  
Resistencia al fuego: 180 minutos  
Resistencia al calor: 1800°C

× FINE REVOLUTION

Fabricación: corte cuchilla rotativa, corte ultrasonido.  
\*\* Making up: rotating knife cutting, ultrasonic cutting.



Ficha Técnica / Technical Data

ENCANT

Composition / Composición	Polyester 100%
Weight / Peso	87 g/m <sup>2</sup>
Thickness / Espesor	0,58 mm.
Tensile Strength (parallel) / Resistencia a la tracción	width: 780 N/5 cm.
Light Fastness / Resistencia a la luz	5 grade
Fire Rating / Clasificación antigrupo	NFPA 701
Width / Ancho	270 cm.

destiny

Your best ally



**encant**

composición 12000



# glamour



**FIRE RETARDANT**

Fabricación: corte cuchilla croniar, corte ultrasonido.  
 Making up: rotating knife cutting, ultrasonic cutting



## Ficha Técnica / Technical Data

	GLAMOUR THIN PART PARTE FINA	GLAMOUR THICK PART PARTE DENSA
Composition / Composición	Polyester 100%	Polyester 100%
Transmittance / Transparencia	84 % - 26 %	84 %
Weight / Peso	138 g/m <sup>2</sup>	138 g/m <sup>2</sup>
Thickness / Espesor	0,28 mm.	1 mm.
Stitch Strength (stitch/Worm) / Resistencia a la tracción	warp-unt. 180 - weft-tramw 200	warp-unt. 2600 - weft-tramw 200
Light Fastness / Resistencia a la luz	> 5 grado (NTT-38 > 3 grado)	> 5 grado (NTT-38 > 3 grado)
Fire Rating / Clasificación de fuego	NFPA 701	NFPA 701
Width / Ancho	290 cm.	290 cm.

destiny

Your best ally

# glamour

composición 6000



NTWT - 004

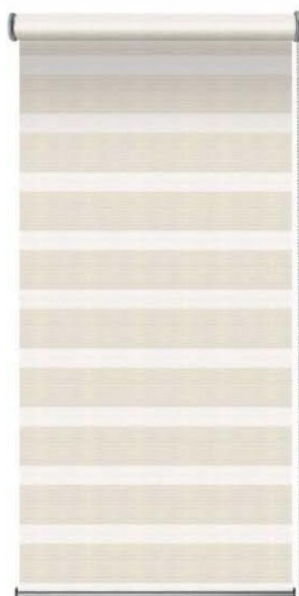

NTWT - 005



NTWT - 006



9



10

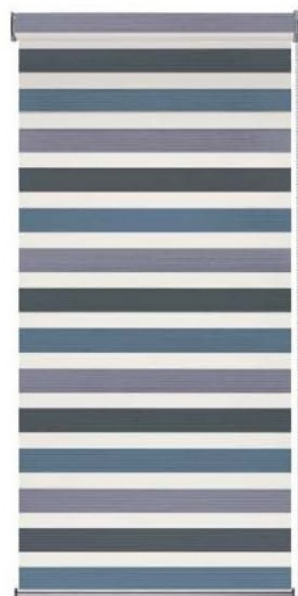

11





linen



Fabricación: corte cuchilla circular, corte ultrasonido.  
#Making up: rotating knife cutting, ultrasonic cutting



#### Ficha Técnica / Technical Data

LINEN

Composicion / Composición	80% Pta. - 20% L
Weight / Peso	115 g/m <sup>2</sup>
Thickness / Espesor	0,33 mm.
Barilla Strength (g/50cm) / Resistencia a la tracción	warp-vert. 80 - weft-irone 1000 N/5cm.
Light Fastness / Resistencia a la luz	4 grado
Width / Ancho	240 cms.

destiny

Your best ally

# linen

composición 12300





look



Fabricação: corte a quente, corte ultrassônico.  
 Making up: rotating knife cutting, ultrasonic cutting.



Ficha Técnica / Technical Data

LOOK

Composition / Composición	Polyester 100%
Weight / Peso	187 g/m <sup>2</sup>
Thickness / Espesor	0,56 mm.
Stiffness (stiffness) / Resistencia a la tracción	wepp-std. 374
Light Fastness / Resistencia a la luz	4 grade
Fire Rating / Clasificación halago	NFPA 701
Width / Ancho	275 cm.

destiny

Your best ally



# look

composición 11800



1



2



3



4



5

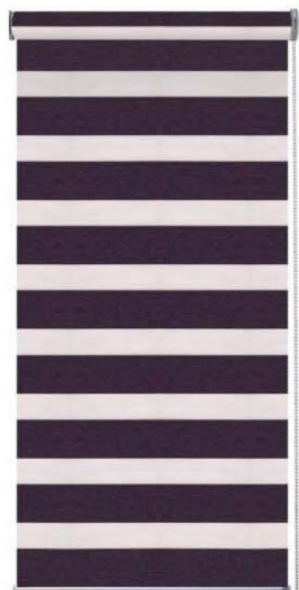

6



**mos**



Fabricación: corte cuchilla circular, corte ultrasonido.  
#Making up: rotating knife cutting, ultrasonic cutting



USO  
maintenance



Ficha Técnica / Technical Data

MOS

Composition / Composición	Polyester 100 %
Weight / Peso	80 g / m <sup>2</sup>
Thickness / Espesor	0,32 mm.
Light Fastness / Resistencia a la luz	4 grade
Width / Ancho	275 cm.

**destiny**

Your best ally

mos

C . 17500

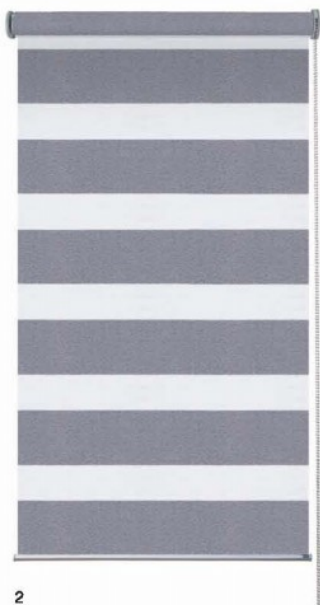





natural



FINE REAROMAT

Fabricación: corte cuchilla circular, corte ultrasonido.  
 #Mixing up: rotating knife cutting, ultrasonic cutting



Ficha Técnica / Technical Data

	NATURAL TRANSLUCENT PART PARTE TRANSLÚCIDA	NATURAL OPAQUE PART PARTE OPACA
Composition / Composición	Polyester 100%	Polyester 100%
Transmittance / Transparencia	80,7 %	22,9 %
Weight / Peso	188 g/m <sup>2</sup>	188 g/m <sup>2</sup>
Thickness / Espesor	0,2 mm.	0,85 mm.
Stitch Strength (shif/ton) / Resistencia a la tracción	warp-ord. 119 - weft-trama 400	warp-ord. 3275 - weft-trama 166
Light Fastness / Resistencia a la luz	5 grado	5 grado
Fire Rating / Clasificación antigraso	NFPA 701	NFPA 701
Width / Ancho	290 cm.	290 cm.

destiny

Your best ally



natural

composición 8700



SN 31



SN 34



SN 84



# romance



**FINE READING**

Fabricación: corte cuchilla circular, corte ultrasonido.  
#Making up: rotating knife cutting, ultrasonic cutting



## Ficha Técnica / Technical Data

ROMANCE

Composition / Composición	Polyester 100%
Transmittance / Transparencia	84 % - 25%
Weight / Peso	180 g/m <sup>2</sup>
Thickness / Espesor	0,24 mm - 1,12 mm
Tensile Strength (tdl/5cm) / Resistencia a la tracción	warp-ord.116,4 - weft-frame 2927,9
Light Fastness / Resistencia a la luz	5 grado
Fire Rating / Clasificación antiqgo	NFPA 701
Width / Ancho	260 cm.

**destiny**

Your best ally

# romance

composición 6100



NTWR - 001



NTWR - 002



NTWR - 003



4



5



6



silver



FINE NEWMONT

Fabricación: corte cuchilla circular, corte ultrasonido.  
 \*\*Making up: rotating knife cutting, ultrasonic cutting



Ficha Técnica / Technical Data

	SILVER TRANSLUCENT PART PARTE TRANSLÚCIDA	SILVER OPAQUE PART PARTE OPACA
Composition / Composición	Polyester 90,5% - Metallized Fibre 9,5 %	
Transmittance / Transparencia	91,1%	41,8 %
Weight / Peso	92,5 g/m <sup>2</sup>	92,5 g/m <sup>2</sup>
Thickness / Espesor	0,2 mm.	0,34 mm.
Twist Strength (dtex) / Resistencia a la tracción	semp-urd.220,3 -sew-frame 101,2	semp-urd. 1837,2 -sew-frame 101,2
Light Fastness / Resistencia a la luz	4 grade	4 grade
Fibre Retting / Clasificación estirgo	No	No
Width / Ancho	290 cm.	290 cm.

destiny

Your best ally



# silver

composición 11100

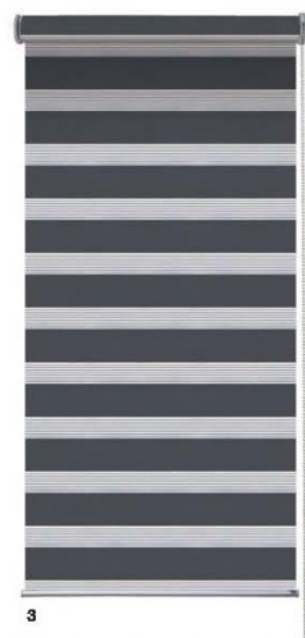

# stripe



Textil del sector de la confección  
Industria de la Seda y el Lino de España  
Industria de la Lana de España

FIRE RESISTANT

Fabricación: corte cuchilla circular, corte ultrasonido.  
# Making up: rotating knife cutting, ultrasonic cutting



## Ficha Técnica / Technical Data

STRIFE

Composition / Composición	Polyester 100%
Transmittance / Transparencia	84% - 25 %
Weight / Peso	80,1 g/m <sup>2</sup>
Thickness / Espesor	0,22 mm - 0,88
Tensile Strength (at/Break) / Resistencia a la tracción	120,8 - 1632,6
Light Fastness / Resistencia a la luz	> 5 grade
Fire Rating / Clasificación halaga	NFPA 701
Width / Ancho	280 cm.

destiny

Your best ally

# stripe

composición 6300



NTWS - 001



NTWS - 002



NTWS - 003

# tetris



**FIRE RETARDANT**

Fabricación: corte cuchilla de rotar, corte ultrasonido.  
 # Making up: rotating knife cutting, ultrasonic cutting



## Ficha Técnica / Technical Data

	TETRIS	TETRIS
	TRANSLUCENT PART PARTE TRANSLÚCIDA	OPAQUE PART PARTE OPAKA
Composition / Composición	polyester 100%	polyester 100%
Transmittance / Transparencia	80 %	37,6 %
Weight / Peso	137,8 g/m <sup>2</sup>	137,8 g/m <sup>2</sup>
Thickness / Espesor	0,27 mm.	0,72 mm.
Tensile Strength (at 50°C) / Resistencia a la tracción	warp-unt. 203,2 - weft-tenne 166,3	warp-unt. 2302,2 - weft-tenne 166,9
Light Fastness / Resistencia a la luz	> 7 grade	> 7 grade
Fire Rating / Clasificación de fuego		
Width / Ancho	290 cm.	290 cm.

destiny

Your best ally



# tetris

composición 10000



1



2



3



4

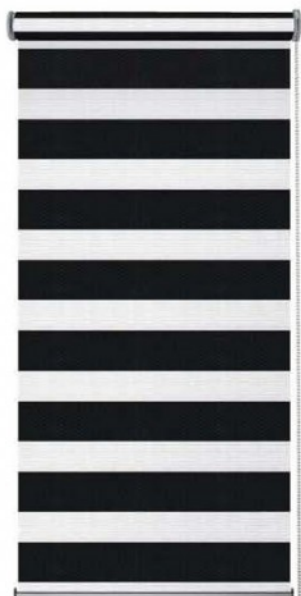

5

# tul acid



Fabricación: corte cuchilla circular, corte ultrasonido.  
# Making up: rotating knife cutting, ultrasonic cutting



USO  
maintenance



## Ficha Técnica / Technical Data

TUL ACID

Composition / Composición	Polyester 100 %
Transmittance / Transparencia	42,6 %
Weight / Peso	203,9 g / m <sup>2</sup>
Thickness / Espesor	0,27 / 0,11 mm.
Tensile Strength (daN/5cm) / Resistencia a la tracción	wepr 952 daN/5cm. / wult 290 daN/5cm.
Light Fastness / Resistencia a la luz	8 grade
Width / Ancho	280 cm.

destiny

Your best ally

# tul acid

C. 17900

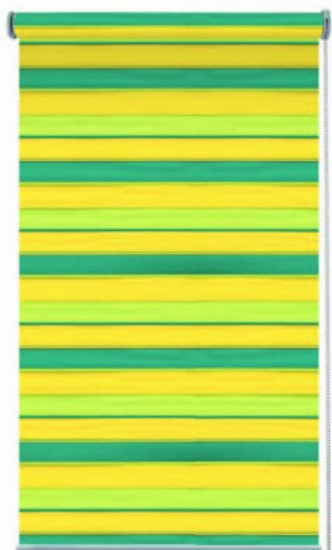

1

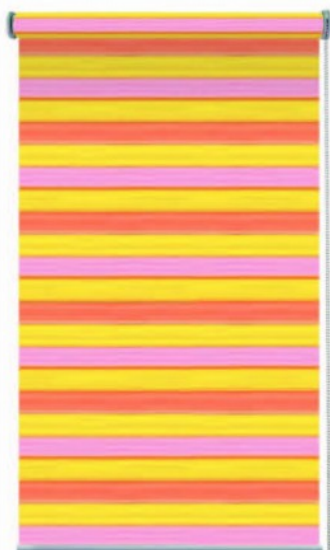

2

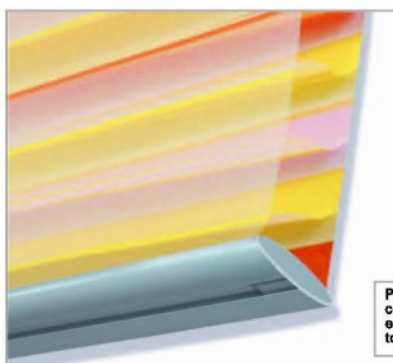

Dependiendo de la posición del contrapeso la altura total oscilará de 0 +/- 5 mm.

Posición del contrapeso cuando el screen está totalmente abierto.



**tul**



Fabricación: corte cuchilla circular, corte ultrasónico.  
 #Making up: rotating knife cutting, ultrasonic cutting



USO  
 maintenance



**destiny**

Your best ally



tul

comp. 17800



1



2



3



4



NATURE 3

dual horizontal compact  
dual horizontal separate  
dual vertical

# dual

## duales

dual duales

destiny

[destinyanddesign.com](http://destinyanddesign.com)

**dual**  
**duales**

**dual** **duales**

**Your best ally**



**dual**  
**compact**

**night & day**  
**noche y día**

**destiny**

[destinyanddesign.com](http://destinyanddesign.com)



# dual compact

night & day  
noche y día





**duales  
horizontales  
compact**



Tejido for treated substrates  
resistente al fuego (Retardant fire fabric)



Fabricación: corte cuchilla circular, corte ultrasonido.  
#Making up: rotating knife cutting, ultrasonic cutting



**2 TEJIDOS DIFERENTES EN UN SÓLO MECANISMO**

*2 different fabrics in a same mechanism*

**2/3 TEJIDO N&D + 1/3 TEJIDO ENROLLABLE O SCREEN**

*2/3 N&D fabrics + 1/3 roller or screen fabrics*

Your best ally

**destiny**

# duales horizontales compact



**duales  
horizontales  
compact**





# duales horizontales compact

composición 9100



mecanismo DUAL blanco o nickel con galería + 2/3 noche /día y 1/3 enrollable, screen o black out.  
mechanism with gallery DUAL white or nickel + 2/3 night/day and 1/3 roller, screen or black out.

P.V.P. recomendado (IVA no incluido) **Recommended P.V.P. (VAT not included)**

alto high m.	ancho / width m.				
	1,00	1,50	2,00	2,50	3,00
1,00	385 €	445 €	512 €	552 €	612 €
1,50	471 €	531 €	598 €	638 €	698 €
2,00	557 €	617 €	684 €	724 €	784 €
2,50	643 €	703 €	770 €	810 €	870 €

Todas las composiciones tendrán el mismo precio. *All the compositions will be heat price.*

LOS DUALES ESTARÁN COMPUESTOS POR CUALQUIER TEJIDO NOCHE/DÍA Y CUALQUIER TEJIDO ENROLLABLE O SCREEN DEL CATÁLOGO.

AMBOS TEJIDOS IRÁN TERMOSELLADOS.

LA ALTURA POSIBLE DEPENDERÁ DE LA COMBINACIÓN DE LOS TEJIDOS ELEGIDOS.

DUAL MECHANISM ARE COMPOSED BY ANY NIGHT&DAY FABRIC ANB BY ANY SCREEN FABRIC YOU MAY ASK FROM THE CATALOGUE.

BOTH FABRICS WILL BE HEAT SEALED-

THE HIGH POSSIBLE DEPENDS FROM THE COMBINATION OF FABRICS CHOSEN.



# dual separate

night & day  
noche y día

destiny

[destinyanddesign.com](http://destinyanddesign.com)

# dual separate

night & day  
noche y día

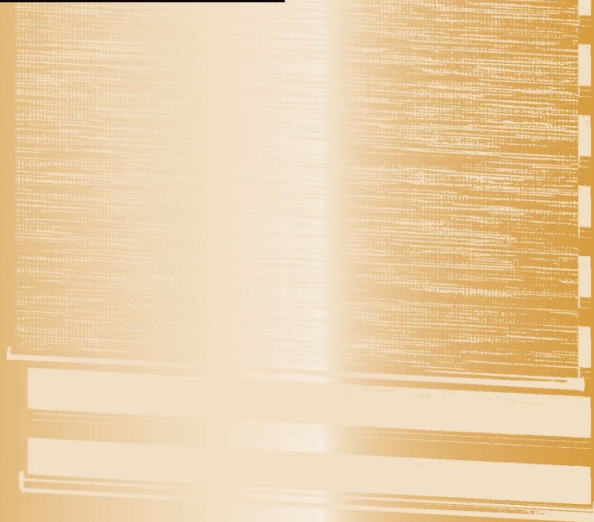

© 2008 HunterDouglas. All rights reserved. HunterDouglas.com



**duales  
horizontales  
separate**



**FIRE RETARDANT**

Fabricación: corte cuchilla circular, corte ultrasonido.  
#Making up: rotating knife cutting, ultrasonic cutting



**2 TEJIDOS DIFERENTES EN UN SÓLO MECANISMO**

*2 different fabrics in a same mechanism*

**2/3 TEJIDO N&D + 1/3 TEJIDO ENROLLABLE O SCREEN**

*2/3 N&D fabrics + 1/3 roller or screen fabrics*

Your best ally

**destiny**





**duales  
horizontales  
separate**

**duales  
horizontales  
separate**

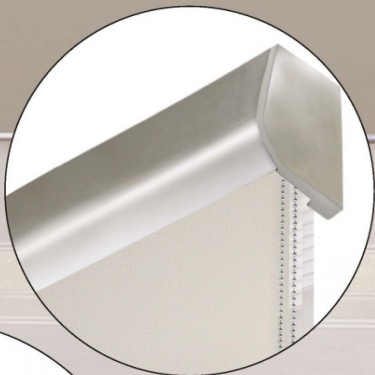

# duales horizontales separate

composición 12800



mecanismo DUAL blanco o nickel con galería + 2/3 noche /día y1/3 enrollable, screen o black out.  
mechanism with gallery DUAL white or nickel + 2/3 night/day and 1/3 roller, screen or black out.



P.V.P. recomendado (IVA no incluido) *Recommended P.V.P. (VAT not Included)*

alto high m.	ancho / width m.				
	1,00	1,50	2,00	2,50	3,00
1,00	385 €	445 €	512 €	552 €	612 €
1,50	471 €	531 €	598 €	638 €	698 €
2,00	557 €	617 €	684 €	724 €	784 €
2,50	643 €	703 €	770 €	810 €	870 €

Todas las composiciones tendrán el mismo precio. *All the compositions will be heat price.*

LOS DUALES LIBRES ESTARÁN COMPUESTOS POR CUALQUIER TEJIDO NOCHE/DÍA Y CUALQUIER TEJIDO ENROLLABLE O SCREEN DEL CATÁLOGO.  
AMBOS TEJIDOS IRÁN SEPARADOS. CUANDO UN TEJIDO SUBE EL OTRO BAJA.  
LA ALTURA POSIBLE DEPENDERÁ DE LA COMBINACIÓN DE LOS TEJIDOS ELEGIDOS.

DUAL FREE MECHANISM ARE COMPOSED BY ANY NIGHT&DAY FABRIC ANB BY ANY SCREEN FABRIC YOU MAY ASK FROM THE CATALOGUE.

BOTH FABRICS WILL BE ARE SEPARATED. WHEN A FABRIC OTHER LOW RISE THE HIGH POSSIBLE DEPENDS FROM THE COMBINATION OF FABRICS CHOSEN.

# dual vertical

night & day  
noche y día



destiny

[destinyanddesign.com](http://destinyanddesign.com)



# dual vertical

night & day  
noche y día

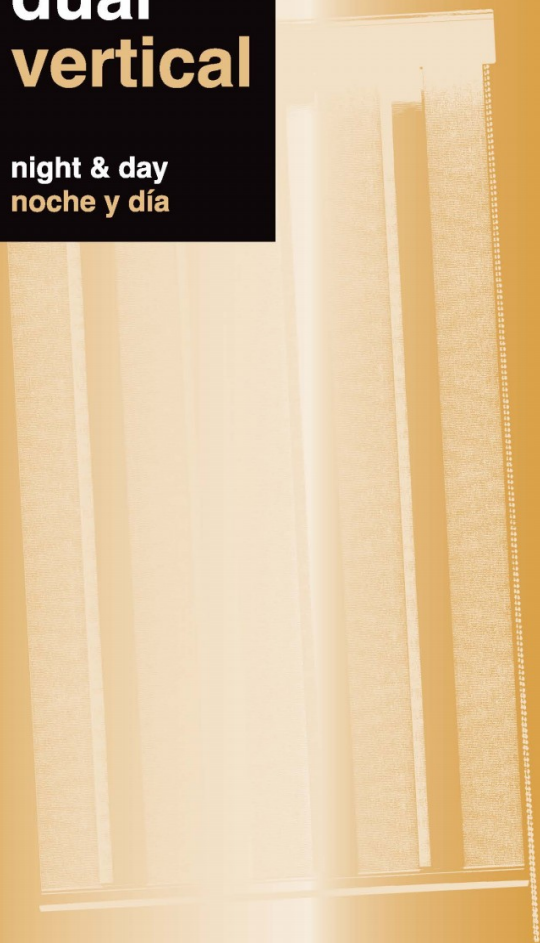



# naturelle



FINE NEWDAMT

Fabricación: corte cuchilla circular, corte ultrasonido.  
 Making up: rotating knife cutting, ultrasonic cutting



## Ficha Técnica / Technical Data

Composición / Composición	NATURELLE	
	TRANSLUCENT PART PARTE TRANSLUCIDA	OPACQUE PART PARTE OPACA
Transmittance / Transparencia	Polyester 100%	Polyester 100%
Weight / Peso	83,1 %	25,3
Thickness / Espesor	171,9 g/m <sup>2</sup>	
Yarns Strength (denier) / Resistencia a la tracción	0,15 mm.	0,48 mm.
Light Fastness / Resistencia a la luz	warp-ord. 110 - weft-ords 400	warp-ord. 3100 - weft-ords 400
Fibre Finning / Clasificación Intago	6 grado	6 grado
Width / Ancho	NPPA 701	NPPA 701
	280 cm.	280 cm.

destiny

Your best ally

# naturelle

composición 10800



1



2



3



4

# night & day store

estor  
noche / día

night & day store  
estor noche / día

destiny

[destinyanddesign.com](http://destinyanddesign.com)



**night  
& day  
store**

**estor  
noche / día**

**night & day store**  
estor noche / día

**Your best ally**



# mecha nism

mecanismos

destiny

[destinyanddesign.com](http://destinyanddesign.com)

**mecha  
nism**

**mecanismos**

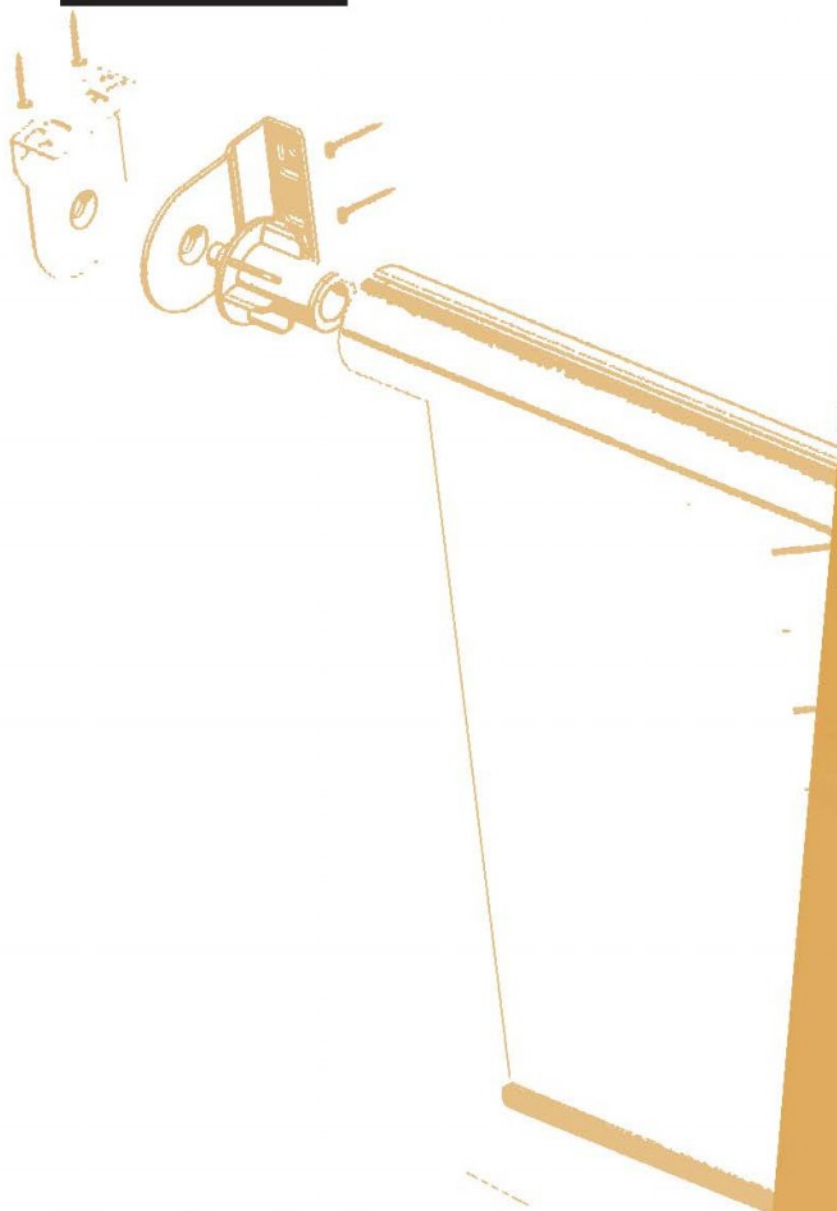

**Your best ally**

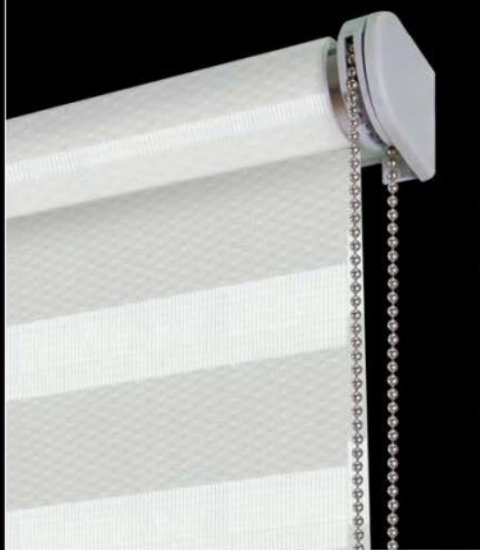

## **mecanismos noche/día**

*night & day  
mechanism*

**titano  
goliat  
zeus  
thor**

**dual  
verti roll**

**mecanismos motorizados**  
*motorized mechanism*

**muelle de compensación**  
*spring roller assist*

**embellecedores y galerías**  
*gallery and beauty covers*

Your best ally

**destiny**



## titano para noche/día for night & day

Tubo 38 mm. Ø estriado    Espesor metal 1,20 mm.  
Tube 38 mm. Ø striated    Metal thickness 1,20 mm.

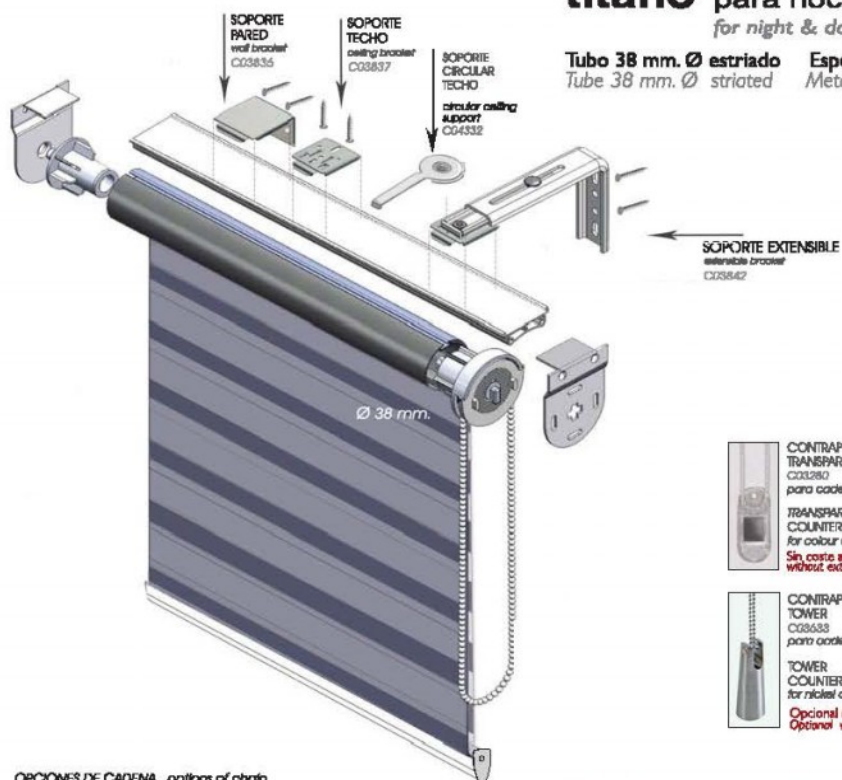

CONTRAPESO  
TRANSPARENTE  
C03280  
para cadenas color  
TRANSPARENT  
COUNTERWEIGHT  
for colour chain  
Sin coste adicional  
without extra cost



CONTRAPESO  
TOWER  
C03635  
para cadenas niquel  
TOWER  
COUNTERWEIGHT  
for nickel chain  
Opcional con coste adicional  
Optional with extra cost

### OPCIONES DE CADENA options of chain

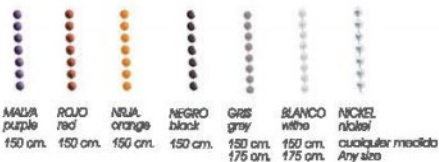

MAZ/A purple 150 cm.  
ROJO red 150 cm.  
NARANJA orange 150 cm.  
NEGRO black 150 cm.  
GRIS gray 150 cm.  
BLANCO white 150 cm.  
NIQUEL nickel cualquier medida Any size

### OPCIONES DE EMBELLECEDOR beauty cover options



EMBELLECEDOR STYLE  
stylo beauty cover  
C03631  
Opcional con coste adicional  
Optional with extra cost

EMBELLECEDOR GRIS  
gray beauty cover  
C03762  
Sin coste adicional  
Without extra cost

EMBELLECEDOR BLANCO  
white beauty cover  
C03798  
Opcional  
Optional

### SOPORTE PARED Wall bracket



### SOPORTE EXTENSIBLE Wall bracket



### SOLUCIÓN DINTEL One touch C04273



## goliat para noche/día for night & day

Tubo 38 mm. Ø estriado    Espesor metal 1,20 mm.  
Tube 38 mm. Ø striated    Metal thickness 1,20 mm.

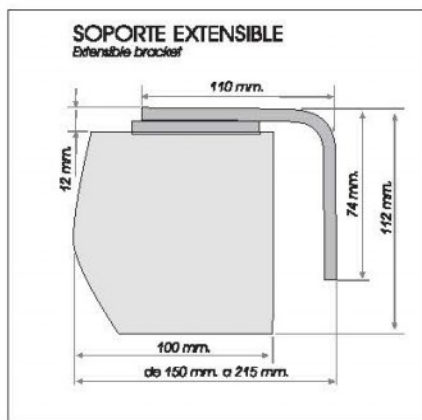
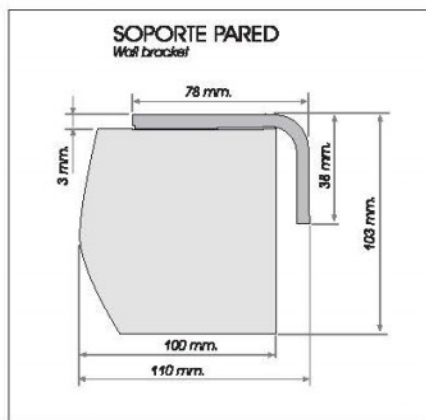
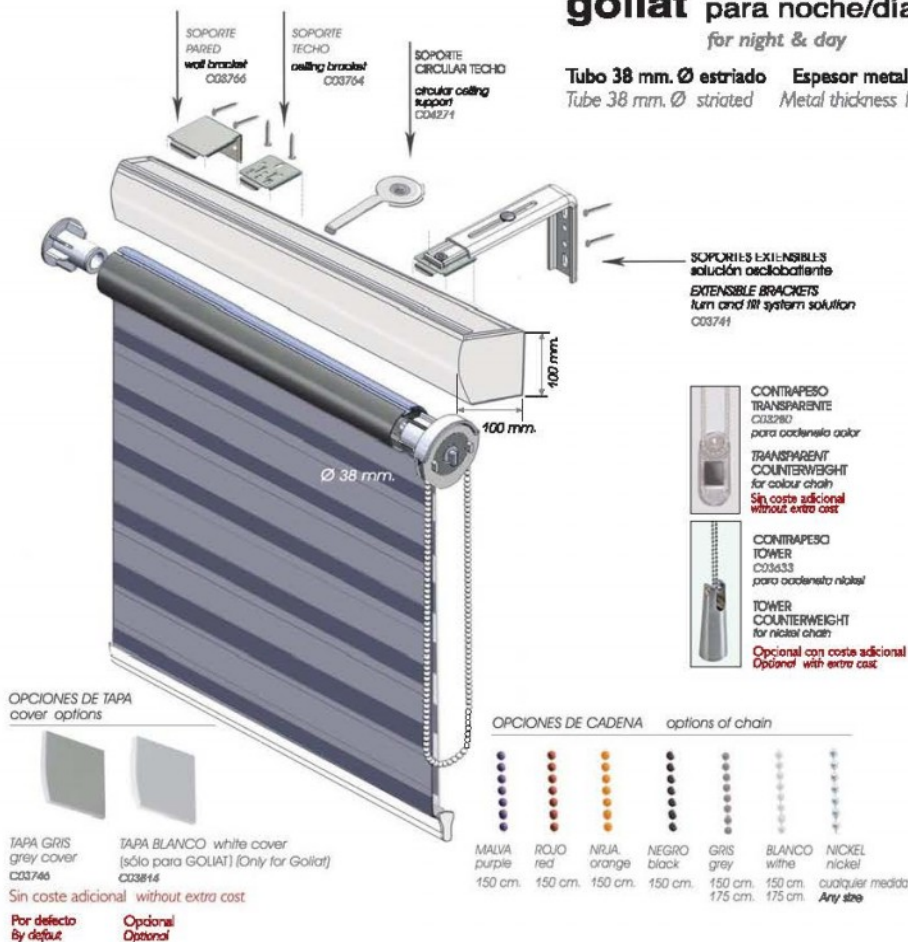

## zeus para noche/día for night & day

Tubo 49 mm. Ø estriado    Espesor metal 2,10 mm.  
Tube 49 mm. Ø striated    Metal thickness 2,10 mm.

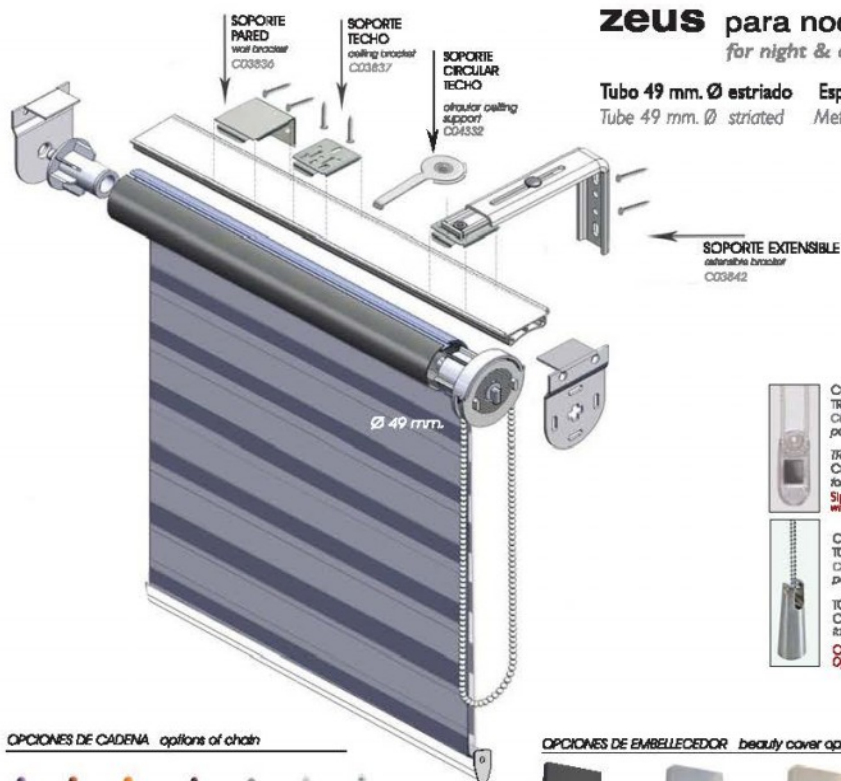

### OPCIONES DE CADENA options of chain

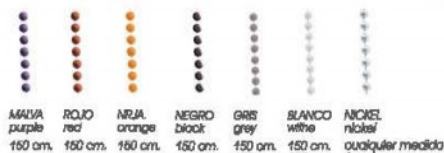

### OPCIONES DE EMBELLECEDOR beauty cover options

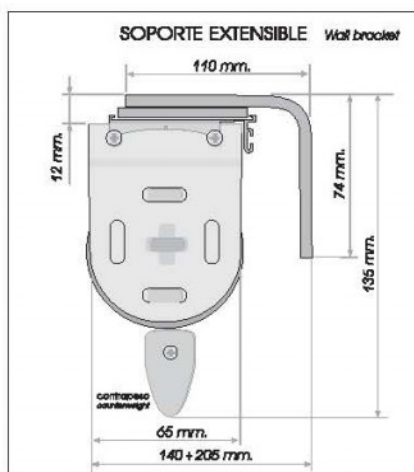
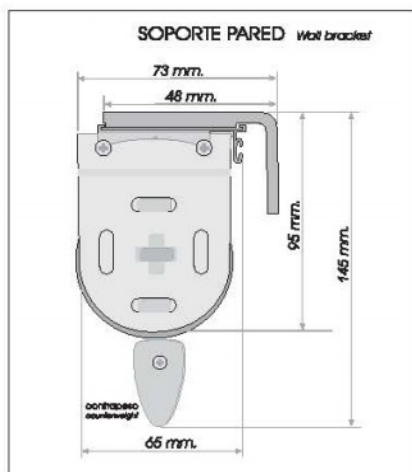

## thor para noche/ día for night & day

Tubo 49 mm. Ø estriado    Espesor metal 2,10 mm.  
Tube 49 mm. Ø striated    Metal thickness 2,10 mm.

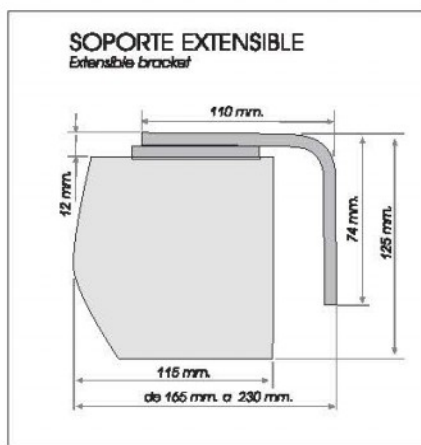
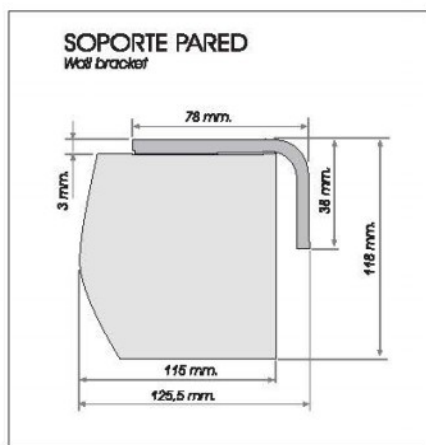
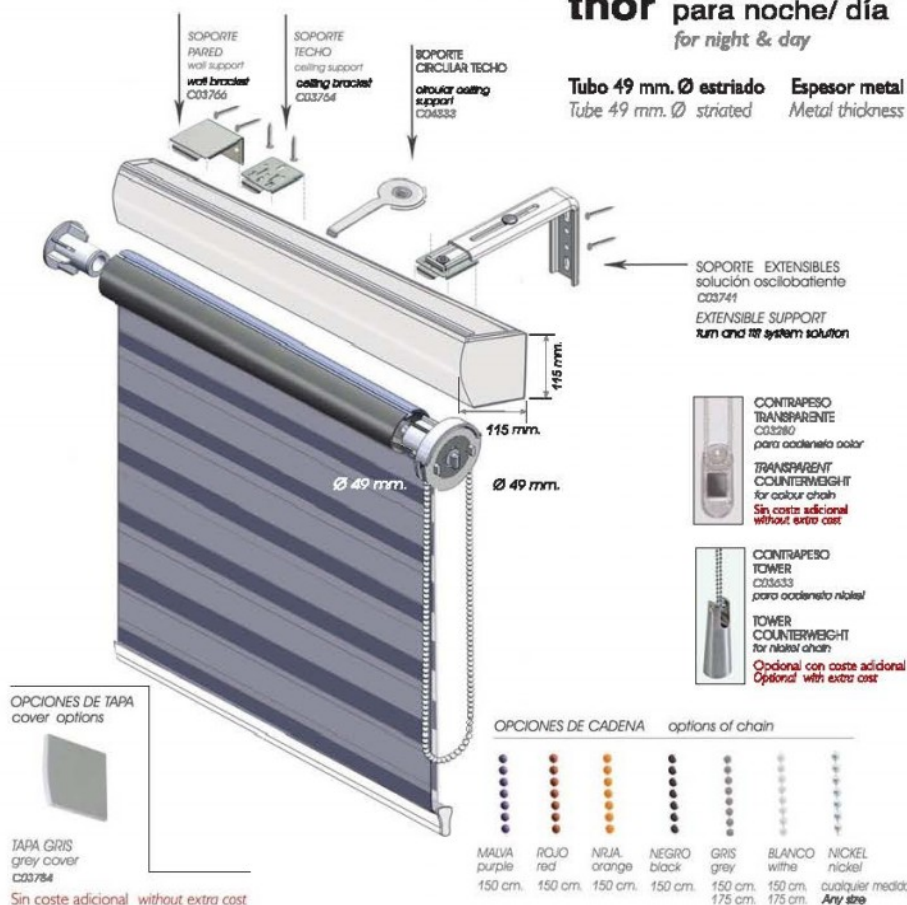



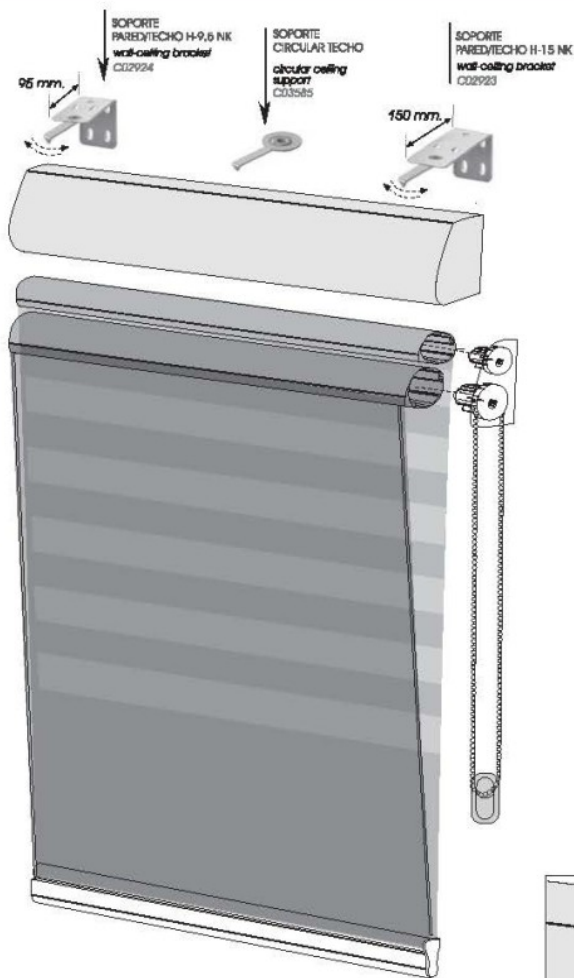

## DUAL para duales for dual

Mecanismo para 2 tejidos diferentes.  
Con capacidad de enrollar hasta 7,5 m.  
de tejido.

*Mechanism for 2 different fabrics.  
With capacity to roll till 7,5 m. of fabrics.*



CONTRAPESO  
TRANSPARENTE  
C03580  
para cadenera color

TRANSPARENT  
COUNTERWEIGHT  
for colour chain  
Sin coste adicional  
without extra cost



CONTRAPESO  
TOWER  
C03633  
para cadenera níquel

TOWER  
COUNTERWEIGHT  
for nickel chain  
Opcional con coste adicional  
Optional with extra cost

### OPCIONES DE CADENA options of chain



MALVA purple 150 cm.	ROJO red 150 cm.	NARANJA orange 150 cm.	NEGRO black 150 cm.	GRIS gray 160 cm. 175 cm.	BLANCO white 160 cm. 175 cm.	NICKEL níquel/ cualquier medida Any size
----------------------------	------------------------	------------------------------	---------------------------	------------------------------------	---------------------------------------	---

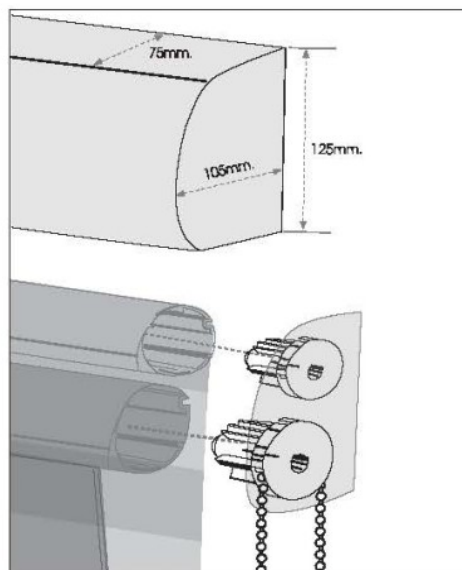

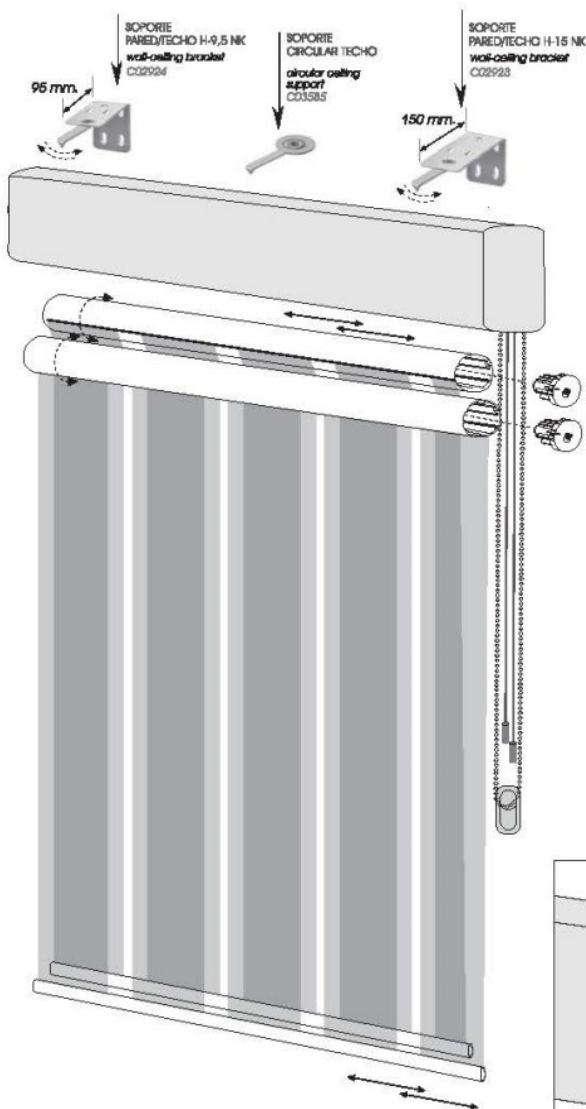

## VERTI ROLL para noche/día vertical for night & day VERTICAL



**CONTRAPESO  
TRANSPARENTE**  
C03280  
para cadenera color  
**TRANSPARENT  
COUNTERWEIGHT**  
for colour chain  
**Sin coste adicional  
without extra cost**



**CONTRAPESO  
TOWER**  
C03653  
para cadenera nickel  
**TOWER  
COUNTERWEIGHT**  
for nickel chain  
**Opcional con coste adicional  
Optional with extra cost**

### OPCIONES DE CADENA options of chain

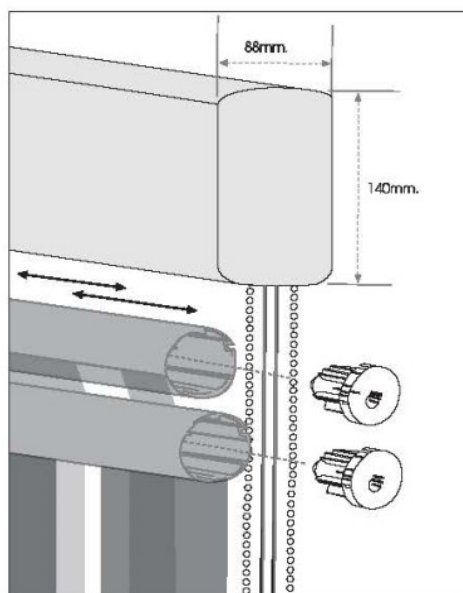
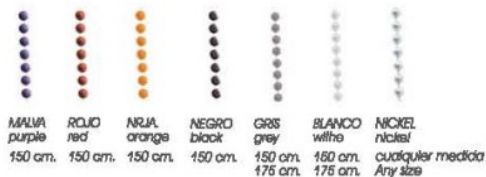

destiny

mecanismos  
mechanism

night & day

MOTORIZADO para TITANO y GOLIAT  
motorized TITANO and GOLIAT

MOTOR SOMFY BATERÍA 1.127



SOPORTE UNIÓN 2 ENROLLABLES  
union 2 roller support

para TITANO - for TITANO para GOLIAT - for GOLIAT

para THOR - for THOR

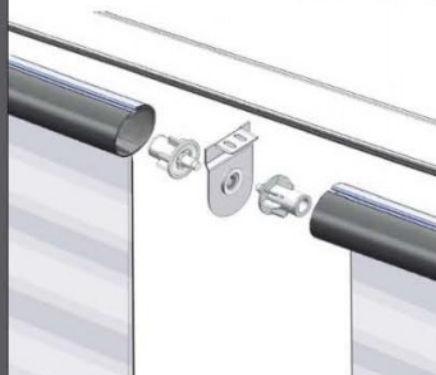

MOTORIZADO para ZEUS y THOR  
motorized ZEUS and THOR

MOTOR SOMFY ALTUS 40 RTS 3/30

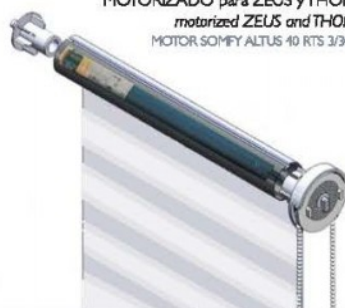

SET ARTICULADO 2 o más ENROLLABLES  
articulation set for two roller or more

para TITANO - for TITANO



MANDO DISTANCIA  
1 CANAL

MOTORIZADO para ZEUS y THOR  
motorized ZEUS and THOR

MOTOR DESTINY U-40

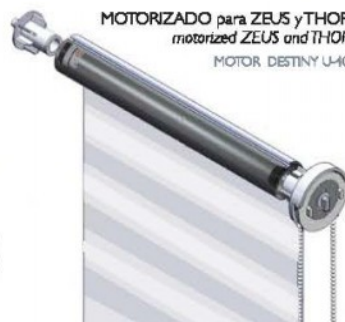

EMBELLECEDOR PREMIUM  
beauty cover PREMIUM

EMBELLECEDOR CORTI-PREMIUM  
beauty cover CORTI-PREMIUM



MUELLE DE COMPENSACIÓN  
spring roller assist

para TITANO y GOLIAT  
TITANO and GOLIAT  
para ZEUS y THOR  
ZEUS and THOR

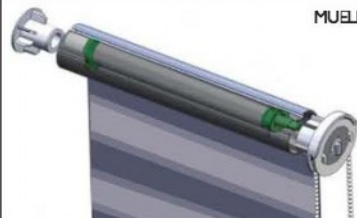

EMBELLECEDOR STYLE  
style beauty cover

para TITANO  
for TITANO



SET GALERÍA SILVER METAL

para TITANO y ZEUS  
TITANO and ZEUS



GALERÍA LINE GALLERY para TITANO y ZEUS  
TITANO and ZEUS



# LOTUS

para enrollable y noche/día  
for rollers and night&day

## mecanismos mechanism

OPCIONES DE CADENA options of chain

MADERA 150 cm	ROJO 150 cm	NARANJA 150 cm	NEGRO 150 cm	GRIS 150 cm 175 cm	BLANCO 150 cm 175 cm	NICKEL cualquier medida Any size

## BAJADA

**BAJADA** SEMIAUTOMÁTICA CONTROLADA para NOCHE Y DÍA

**BAJADA** SEMIAUTOMÁTICA CONTROLADA para ENROLLABLE

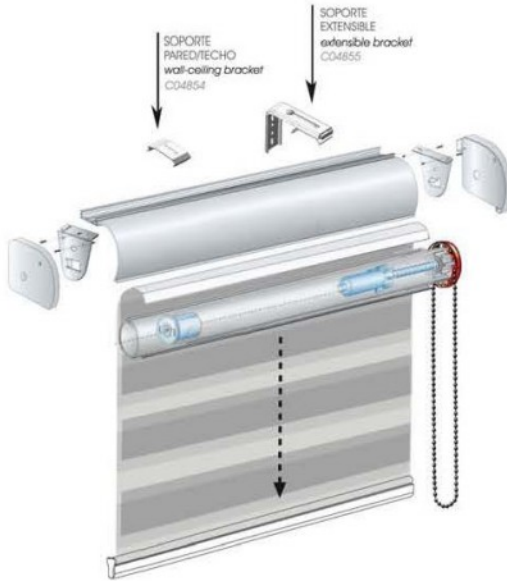

## SUBIDA

**SUBIDA** SEMIAUTOMÁTICA CONTROLADA para NOCHE Y DÍA

**SUBIDA** SEMIAUTOMÁTICA CONTROLADA para ENROLLABLE





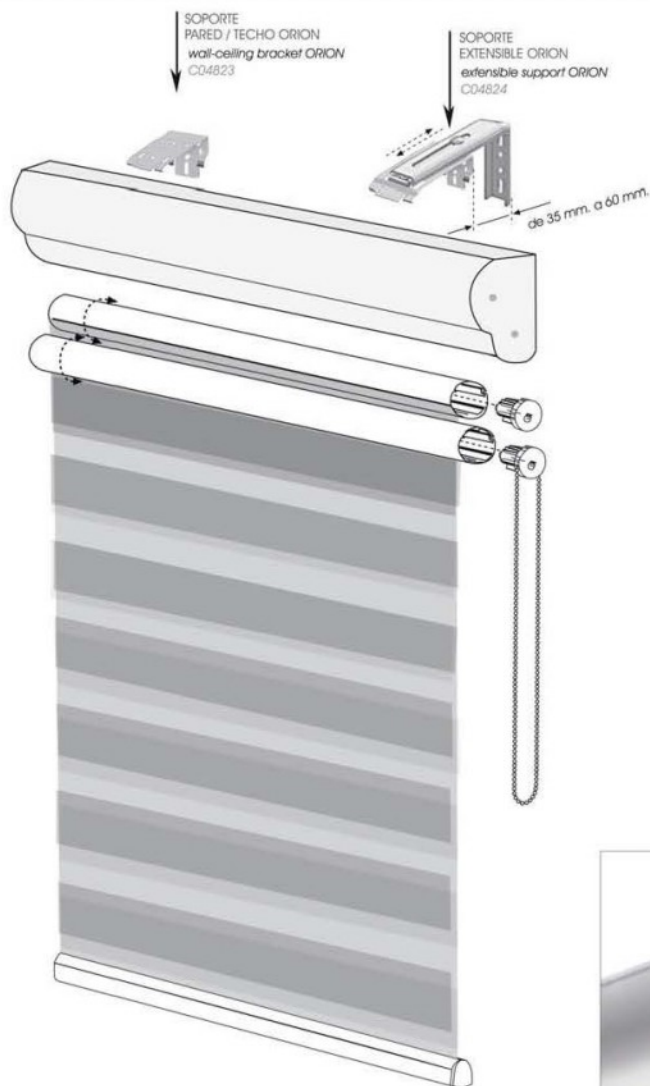

**ORION**  
sólo para noche/día

only for night & day



OPCIONES DE CADENA options of chain





**mecanismo**  
**BUNKER**  
NICKEL

**BUNKER NICKEL**  
*mechanism*



**gran capacidad**  
*high capacity*

**2 TEJIDOS DIFERENTES EN UN SOLO MECANISMO**  
*2 different fabrics in a same mechanism*  
**2/3 TEJIDO N&D + 1/3 TEJIDO ENROLLABLE O SCREEN**  
*2/3 N&D fabrics + 1/3 roller or screen fabrics*

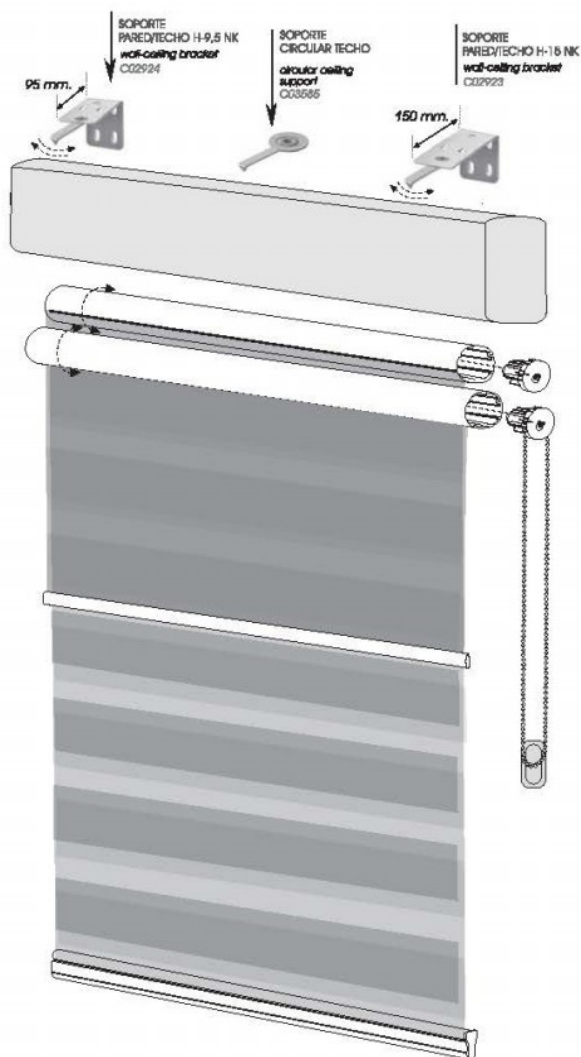

## BUNKER NICKEL

de gran capacidad  
para duales compact o separate  
high capacity  
for dual compact or separate



CONTRAPESO  
TRANSPARENTE  
C03280  
para cadenera color  
TRANSPARENT  
COUNTERWEIGHT  
for colour chain  
Sin coste adicional  
without extra cost



CONTRAPESO  
TOWER  
C03633  
para cadenera nickel  
TOWER  
COUNTERWEIGHT  
for nickel chain  
Opcional con coste adicional  
Optional with extra cost

### OPCIONES DE CADENA options of chain



MALVA purple 150 cm.	ROJO red 150 cm.	NARANJA orange 150 cm.	NEGRO black 150 cm.	GRIS grey 150 cm. 175 cm.	BLANCO white 150 cm. 175 cm.	NICKEL nickel cualquier medida Any size
----------------------------	------------------------	------------------------------	---------------------------	------------------------------------	---------------------------------------	---

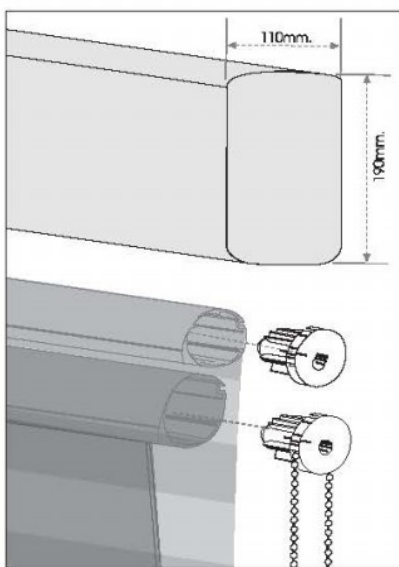

## ISIS

### PARA TEJIDO SCREEN

Sistema de cortina enrollable con acabado acero.

FOR SCREEN FABRICS  
Roller blind system with steel finish.

### MEDIDAS INSTALACIÓN

Installation measures

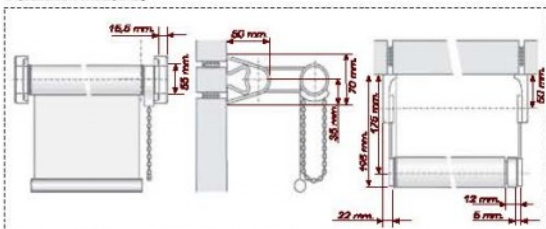

Ø 43 mm.

\*consultar precios....

## OSIRIS

### PARA TEJIDO N&D

Sistema de cortina enrollable con acabado acero.

FOR N&D FABRICS  
Roller blind system with steel finish.

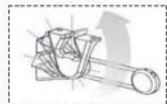

Ø 43 mm.

\*consultar precios....

## FENIX

### PARA TEJIDO N&D y/o SCREEN

Sistema de cortina enrollable con acabado acero.

Consta de dos tubos de iguales dimensiones, para la instalación de dos tejidos screen o noche y día.

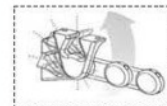

Ø 43 mm.

### FOR N&D AND SCREEN

Roller blind system with steel finish.  
It consists of two tubes of equal dimensions for the installation of two fabrics screen or night and day



# carta de colores RAL para galerías y contrapeso

RAL color chart for galleries  
and counterweight

destiny

COLORES ref. RAL    colours ref. RAL

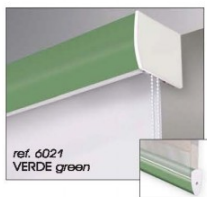
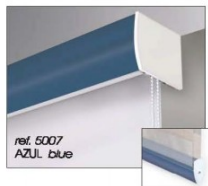

Los embellecedores laterales serán blancos o grises dependiendo del standard del mecanismo

The lateral covers will be white or grey depending on the mechanism standard

EFFECTO MADERA    wooden effect



MADERA CLARO  
clear wood



MADERA OSCURO  
dark wood



**mecanismo  
MERCURE**  
*mercure mechanism*

destiny

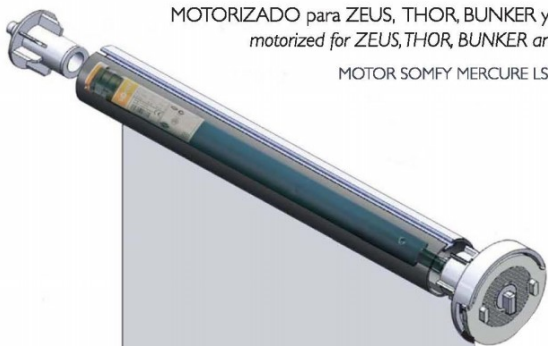

MOTORIZADO para ZEUS, THOR, BUNKER y VERTIROLL  
*motorized for ZEUS, THOR, BUNKER and VERTIROLL*

MOTOR SOMFY MERCURE LS 40 WT 3/30 S  
CO4287



## mando SOMFY 16 canales



CO4890

MANDO TELIS 16 RTS PURE  
para motores SOMFY capaz de operar hasta 16 motores.

*TELIS 16 RTS PURE CONTROL SOMFY motor  
able to operate up to 16 engines.*

De fácil programación y que permite nombrar  
la estancia en cada uno de los canales,  
así como los mecanismos a operar.

*Easy programming and allows you to name the room  
in each of the channels as well as mechanism to operate.*

para ZEUS, THOR, BUNKER y VERTIROLL  
*for ZEUS, THOR, BUNKER and VERTIROLL*



destiny

[destinyanddesign.com](http://destinyanddesign.com)

Your best ally